

DELLA

USER MANUAL

WATER DISPENSER WITH ICE MAKER

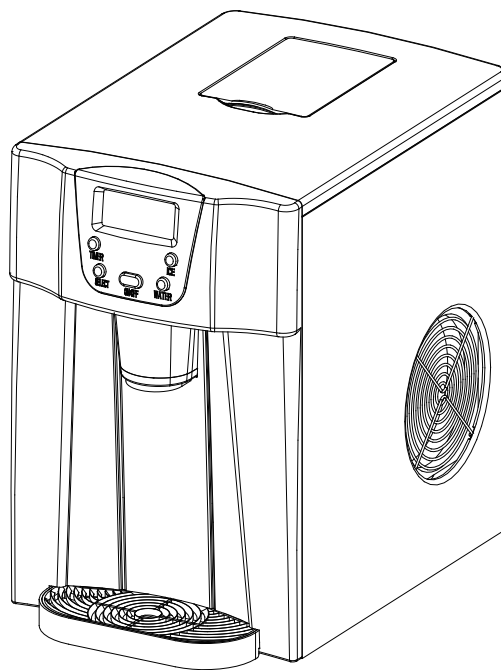

Model: 048-GM-48293,048-GM-48294

To ensure proper use of this appliance and your safety, please read the following instructions carefully before operating this appliance.

IMPORTANT SAFETY INSTRUCTIONS

IMPORTANT SAFETY INSTRUCTIONS	2
PREPARING YOUR ICE MAKER FOR USE	
IMPORTANT SAFETY TIPS.....	3
GETTING TO KNOW YOUR UNIT	4
OPERATING PROCEDURES & MAINTENANCE	
UNPACKING YOUR ICE MAKER.....	5
CONNECTING YOUR ICE MAKER.....	5
CLEANING AND MAINTAINING YOUR ICE MAKER.....	5
USING YOUR ICE MAKER	6-8
TROUBLESHOOTING.....	9
CIRCUIT DIAGRAM	10
CIRCUIT DIAGRAM	10

Your safety and the safety of others are very important.

We have provided many important safety messages manual and your appliance.
Always read and obey all safety messages.

This is the safety alert symbol:



All safety messages will follow the safety alert symbol and the word “DANGER” or “WARNING”.



These words mean:

You can be killed or seriously injured if you don't immediate follow instructions.

All safety messages will tell you what the potential hazard is, tell you how to reduce the chance of injury, and tell you what can happen if the instructions are not followed.

PREPARING YOUR ICE MAKER FOR USE

IMPORTANT SAFETY TIPS

When using electrical appliances, basic safety precautions should be followed to reduce the risk of fire, electric shock, and injury to persons or property. Read all instructions before using any appliance.

- Do not operate this, or any other appliance with a damaged cord.
If the supply cord is damaged, it must be replaced by the manufacturer or its service agent or a similarly qualified person in order to avoid a hazard.
This ice-maker must be positioned so that the plug is accessible .
Connect to properly grounded outlets only. No other appliance should be plugged into the same outlet. Be sure that the plug is fully inserted into the receptacle.
- Do not run the power cord over carpeting or other heat insulators. Do not cover the cord. Keep cord away from traffic areas, and do not submerge in water.
- We do not recommend the use of an extension cord, as it may overheat and become a risk of fire. If you must use an extension cord, use No.14AWG minimum size and rated no less than 1875 watts.
- Unplug the ice maker before cleaning or making any repairs or servicing.
- Exercise caution and use reasonable supervision when appliance is used near children.
- Do not use your ice-maker outdoors. Place the ice-maker away from direct sunlight and make sure that there is at least 6 inches of space between the back of your unit and wall. Keep a minimum distance of 6 inches on each side of your unit free.
- Do not use other liquid to make the ice-cube other than water.
- Do not clean your ice maker with flammable fluids. The fumes can create a fire hazard or explosion.
- Do not tip over.
- If the ice maker is brought in from outside in wintertime, give it a few hours to warm up to room temperature before plugging it in.

WARNING: This appliance must be earthed.

IMPORTANT:

The wires in this mains lead are colored in accordance with the following code:

Green or Green with a strip yellow:	Grounding
White:	Neutral
Black:	Live

To avoid a hazard due to instability of the appliance, it must be placed at an even or flat surface.

GETTING TO KNOW YOUR UNIT

1. Water drip tray:
2. Water drip tray cover: Also used for the support of the ice-cube container
3. Water drain plug: For draining water from water reservoir.
4. Hot Air outlet
5. Top window
6. Ice cube pushing spring
7. Control Panel: Easy to use, visible functions touch display setting.

A.: LCD display window

- 1: TIMER setting delay time
- 2: Ice-cube size displaying: Small size.
- 3: Ice-cube size displaying: Large size.
- 4: Ice-cube obtaining symbol: with this symbol, the ice-cube will be pushed out.
- 5: Water dispensing symbol: with this symbol, water is flowing out now.
- 6: Error code.
- 7: Lack of water in reservoir symbol: with this symbol, the unit will stop running, need to pour water in.

8. Ice-full symbol, when it display, means the ice storage area is full of ice-cube.
9. ON/OFF symbol, if the unit has been turned off, this symbol will flash; And if the unit is turned on, this symbol will always display.

B.: Ice-cube obtaining button

C.: Water dispenser button

D.: ON/OFF Button: to start ice-making cycle

E.: SELECT Button: to select the size of the ice cube and the number code of all kinds of delay time

F.: TIMER Button: to setting the timer-on or timer-off program

8. Evaporator

9. Side door: For water filling in and to clean the water reservoir.

10. Water reservoir and the MAX level mark of water

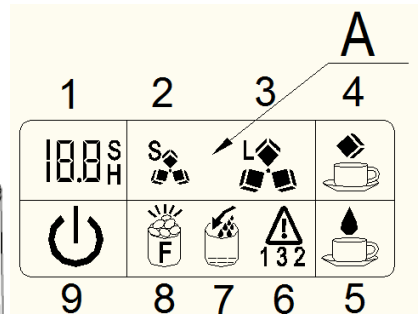
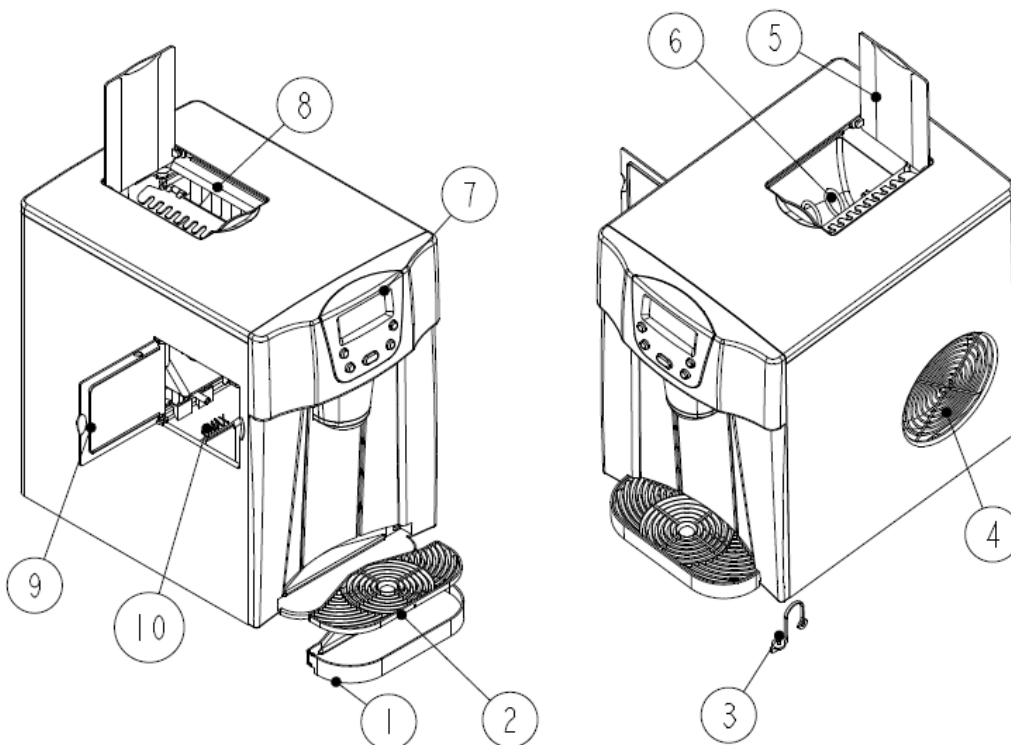
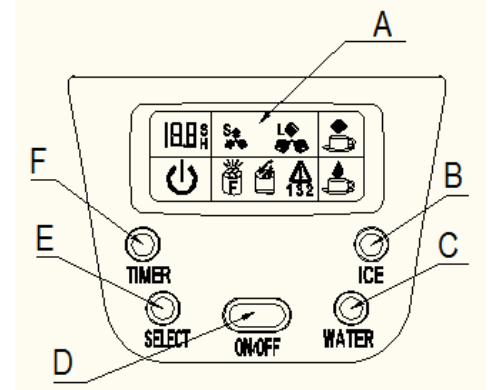

OPERATING PROCEDURES & MAINTENANCE

UNPACKING YOUR ICE MAKER

1. Remove the exterior and interior packaging, Then check all the accessories are included. If any parts are missing, please contact our customer service.
2. Remove all the tapes on the unit. Open the transparent window, take out the accessory parts inside.
3. Clean the interior (such as water reservoir, Ice cube pushing spring etc.) with lukewarm water and a soft cloth.
4. Locating your ice maker on a level counter table far from direct sunlight and other sources of heat (i.e.: stove, furnace, radiator). Make sure that there is at least 6 inches between the back and sides of your ice maker with the wall.
5. Allow one hour for the refrigerant fluid to settle down before plugging your ice maker in.
6. The power plug must be accessible directly.

WARNING: fill with potable water only. Only use drinking water.

CONNECTING YOUR ICE MAKER



***Improper use of the grounded plug can result in the risk of electrical shock. If the power cord is damaged please call our customer service.**

1. This unit should be properly grounded for your safety. The power cord of this appliance is equipped with a grounding plug which mates with standard grounding wall outlets to minimize the possibility of electric shock.
2. Plug your appliance into an exclusive, properly installed, grounding wall outlet. Do not under any circumstances, damage the grounding means of the plug. Any questions concerning power and/or grounding should be directed toward a certified electrician.
3. This appliance requires a standard 110-120Volt, 60Hz electrical outlet with good grounding means.

CLEANING AND MAINTAINING YOUR ICE MAKER

Before using your ice maker, it is strongly recommended to clean it thoroughly.

Unplug the unit before cleaning or making any maintenance.

1. Take out the accessory parts under top window.
2. Clean the interior with diluted detergent, warm water and a soft cloth. First pour the warm water with diluted detergent into the internal water reservoir and the space below the transparent window, then use the soft cloth to wipe the surface.
3. Again use the water to rinse the inside parts, and drain out the water by unplugging the drain cap on the bottom.
4. The outside of the ice maker should be cleaned regularly with a mild detergent solution and warm water.
5. Dry the interior and exterior with a soft cloth.
6. When the machine is not in use for a long time, open water drain cap to drain out water completely from water reservoir.



USING YOUR ICE MAKER

How to start the unit

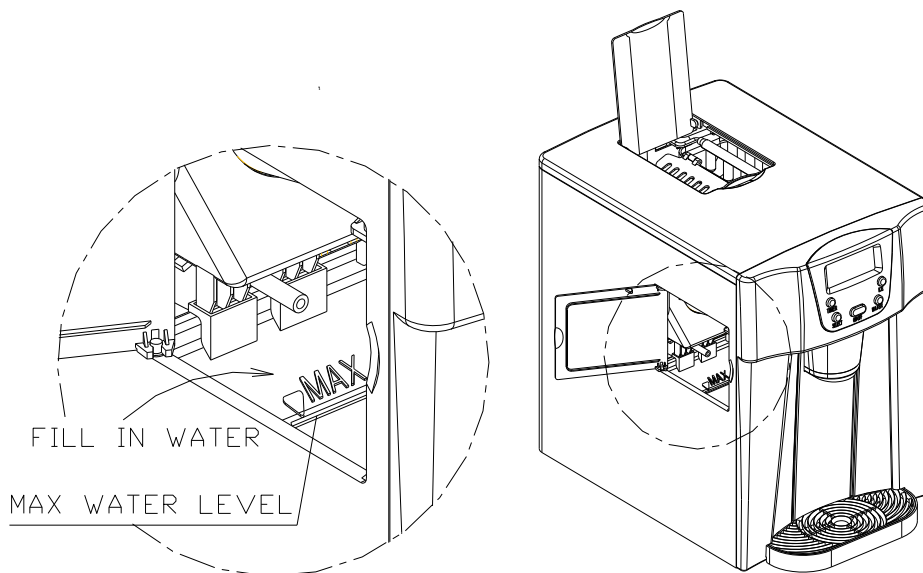

1. Open the left side door, pour potable water into water reservoir. Keep water level **below** the “MAX” water level mark.



2. Plug your ice-maker into the main power outlet, then the “” symbol will flash in LCD display window.

3. Press “ON/OFF” button on the control panel to begin the ice making cycle. After this, the “” symbol will change to light on always in LCD display window, and “” symbol will flash on in the mean time.

The default size of ice-cube is Large. If you want to select the size of the ice cube, just press the

“SELECT” button to select between Large size  and Small size . If you still think the ice cube size is not fit for you, you can add the each ice-making cycle time by “SELECT” button. During the unit ice-making running or on standby mode, always press the “ON/OFF” button for more than 5 seconds, digit “0” will appear in the TIMER delay time displaying area of LCD window, which means the standard time of the once ice-making process, continue to press the “SELECT” button, the digit will change from 0 to 1, again 2, then return 0. After 5 seconds, the setting will complete and the digit will disappear and be remembered by the controller. With digit 1 setting, it will add 1 minute to standard duration time of each ice-making cycle, and the digit 2 setting, the added time will be longer more. And if the unit is plugged on again, it will recover to the digit 0 setting with standard time.

4. The ice making cycle lasts 6 to 12 minutes, depending on the normal size of the ice cube selection and the ambient temperature.

5. While the ice-maker is on, verify water level periodically. If water pump can't pump out water, the ice

maker will stop automatically, and the  symbol will light on LCD displaying window and the arrow symbol will flash. Need to pour water into the water reservoir inside.

We suggest you should press "ON/OFF" button to turn off the unit first, then fill water up to the MAX level mark, again press "ON/OFF" button to restart the unit. If you only fill the water in, but doesn't press any button, you will need to wait some time to desire the ice-cube. Allow the refrigerant liquid inside the compressor at least 3 minutes to settle before restarting.

When Ice Full indicator is on

6. The ice maker automatically stops working when the ice-cube is full inside and the  "F" ice full" symbol on LCD displaying window will be indicated and letter "F" will flash at same time..

How to obtain the ice-cube

7. Put your ice-cube container on drip tray, press the "ICE" button one time on control panel (Button B

in above illustration), the  symbol will light on the LCD window, then the ice cube pushing spring start to rotate, the ice-cube will fall down into your ice-cube container from the ice-cube tap.

And press the "ICE" button again, the  symbol will disappear in the LCD window, the internal pushing spring will stop rotating and the ice-cube will not flow out again.

How to dispense the water

Default time of water flowing:10S.

8. Put your water cup on drip tray, press the "WATER" button once on control panel (Button C in above

illustration), the water will flow out from middle water tap, and the  symbol will light on and the "10 S" will display in the TIMER delay time displaying area of LCD window, with the time pass,

after 10 seconds, the  symbol disappears and water dispensing will finish and water will not flow out again. Among 10 seconds, press the "WATER" button again, it will finish the water dispensing process.

If the water flowing time is too short or too long, you can set it again yourself. Always press the "WATER" button for more than 5 seconds, "10" will appear in the TIMER delay time displaying area of LCD window, continue to press the "SELECT" button to select the suitable time which range is from 7 seconds to 25 seconds. After 5 seconds, the setting will complete and the new digit will disappear and be remembered by the controller. Next time, if you want to dispense the water, it will work according to the new set time..

How to drain out the water inside the unit

9. When you clean the unit internal parts or change the drinkable water, need to drain out the left water in

the water reservoir, just unplug the water drain cap which located at the bottom of the unit and near the water drip tray, the water will flow out from the unit completely.

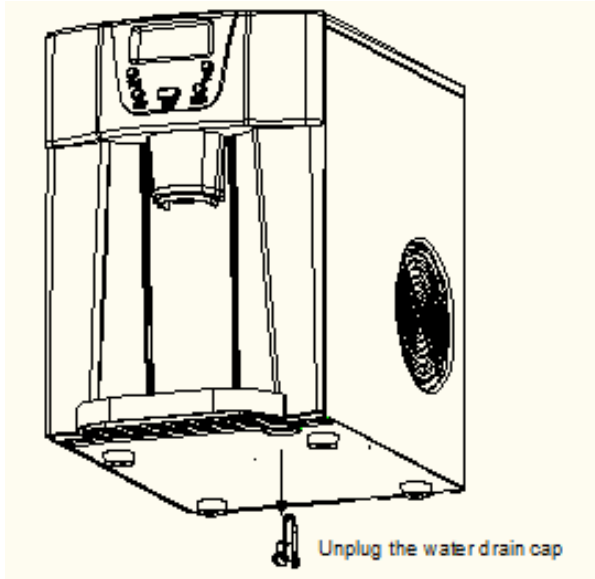

- Change water in the water reservoir every 24 hours to ensure a reasonable hygiene level. If the unit isn't to be used, drain all water & dry the water reservoir.

TIMER SETTING

Timer Delay Time Range: 0.5-19.5 hours.

Default Delay Time: 1 hour.

When the unit is running, you can set the unit with OFF-TIMER to let the unit stop running after your set delay time.

And when the unit is on standby, you can set the unit with ON-TIMER to let the unit start to run automatically after your set delay time, then when you go back home or have a dinner, you can enjoy the happy life that this ice-maker give to you.

How to set the timer





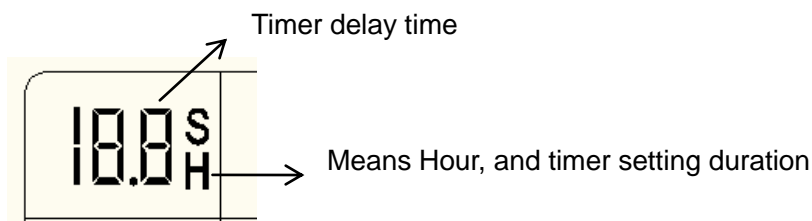

Press the "TIMER" button first, the default delay time is 1.0 hour displayed delay time in LCD display window, then press the "SELECT" button to select your desired delay time. Each press SELECT button one time, the delay time will increase 0.5 hour, but if you always press the SELECT button, the delay time will change very quickly. During the process of delay time adjusting, the letter "H" will flash, then after 5 seconds flashing without pressing, the "H" letter will change from flashing to always displaying, means the timer program has been completed.

How to cancel the timer

When the unit has been set with the timer, press the TIMER button, then the delay time digit and "H" letter display will disappear, mean the timer set has been canceled.



TROUBLESHOOTING

PROBLEM	POSSIBLE CAUSE	SOLUTION
 <p>“  ” symbol is lightening on and the arrow flashes.</p>	Lack of Water.	Stop the ice maker, fill water, and press “ON/OFF” button again to restart the unit.
 <p>“  ” symbol is lightening and letter “F” flashes.</p>	There is too much ice.	Suggest you to obtain the ice-cube.
	No ice cube inside.	Remove the probable obstacle inside or clean the inside wall of the ice storage, if still can't start to ice making process, press “SELECT” for more than 5 seconds to run the ice making for 10 cycles at most.
	Ambient temperature sensor breakdown	The unit can still work, but suggest to call the manufacturer service man or electrical technician to change to a new sensor.
	The ice-making box can not reset normally.	Call the manufacturer service man or qualified technician to check the problem.
Ice cubes on the evaporator stick together.	The ice cycle is too long.	Stop the ice maker, and restart it after the ice blocks melt. Select the small size ice cube selection.
	Water temperature in inner tank is too low.	Change the water in the inner Tank. Temperature of water is better set between 45-90 Fahrenheit degree .
There are ice-cube inside the unit, but can't dispense the ice-cube when you push the “ICE” button.	Moving shaft for the Ice-cube is blocked.	Release the button for ice-cube for 3 seconds, then again push the “ICE” button.
Ice making cycle is normal but no ice is made.	Ambient temperature or water temperature in inner tank is too high.	Please run the ice maker below 90 Fahrenheit degree ambient and pour colder water into tank.
	Refrigerant liquid leakage.	Verify by a qualified technician.
	Pipe in the cooling system is blocked.	Verify by a qualified technician.

CIRCUIT DIAGRAM

