

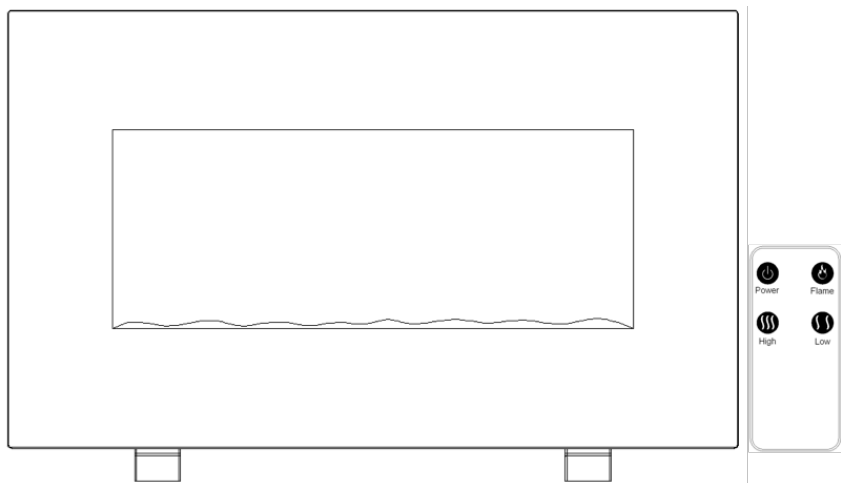

****WARNING: READ THIS INSTRUCTION MANUAL CAREFULLY BEFORE USE.**
www.dellaproductsusa.com 909.344.2588

36" WALL MOUNTED FIREPLACE



INSTRUCTION MANUAL

Item No: 050-HA-50138



OUR BRAND

Thank you for choosing a DELLA Infrared Zone Heating System. This owner's manual will provide you with valuable information necessary for the proper care and maintenance of your new product. Please take a few moments to thoroughly read the instructions and familiarize yourself with all the operational aspects of your new heater.

PLEASE LIKE, COMMENT AND SUBSCRIBE



TABLE OF CONTENT

IMPORTANT INSTRUCTIONS	04
SPECIFICATIONS	05
SAFETY FEATURE	05
PRODUCT OPERATION METHOD	06
IN THE BOX	06
PRODUCT DIAGRAM	06
CONTROL PANEL	07
REMOTE CONTRAL	07
WLL-MOUNTED INSTALLATION	10
TABLE TOP INSTALLATION INSTRUCTIONS	12
OPERATION INSTRUCTIONS	12
MAINTENANCE	14
STORAGE	14
BASIC TROUBLESHOOTING	14
WARRANTY	15

IMPORTANT INSTRUCTIONS

When using this electric unit, basic safety precautions should always be followed to reduce the risk of fire, electric shock, and injury to persons, including the following:

01. Read ALL instructions before using this unit.
02. CAUTION: Risk of Electric Shock. DO NOT open or try to repair the heater yourself.
03. This heater may get hot when in use. To avoid burns, DO NOT let bare skin touch hot surfaces. If provided, use handles when moving this heater.
04. Keep combustible materials, such as furniture, pillows, bedding, paper, clothes, and curtains at least 3 ft from the front of the heater and keep them away from the sides, top, and rear. DO NOT place towels or other objects on the heater.
05. Extreme caution is necessary when any heater is used by or near children or the disabled, or when the heater is left operating and unattended.
06. DO NOT operate any heater with a damaged cord or after the heater malfunctions, has been dropped or damaged in any manner. Return heater to authorized service facility for examination, electrical or mechanical adjustment, or repair.
07. This heater is not intended for use in bathrooms, laundry areas and similar indoor locations. NEVER locate heater where it may fall into a bathtub or other water container. To protect against electrical hazards, DO NOT immerse in water or other liquids.
08. DO NOT touch the control panel or plug with a wet hand.
09. DO NOT run cord under carpeting. DO NOT cover cord with throw rugs, runners, or similar coverings. Arrange cord away from traffic area and where it will not be tripped over.
10. DO NOT insert or allow foreign objects to enter any ventilation or exhaust opening as this may cause an electric shock or fire, or damage the heater.
11. To prevent a possible fire, DO NOT block the air intakes or exhaust in any manner. DO NOT use on soft surfaces, like a bed, where openings may become blocked.
12. A heater has hot and arcing or sparking parts inside. DO NOT use in areas where gasoline, paint, explosive and/or flammable liquids are used or stored. Keep unit away from heated surfaces and open flames.
13. Always plug heaters directly into a wall outlet/receptacle. Never use with an extension cord or relocatable power tap (outlet/power strip).
14. To avoid fire or shock hazard, plug the unit directly into a 120 V AC electrical outlet.
15. To disconnect heater, turn controls to OFF, then remove plug from outlet. Pull firmly on the plug, DO NOT unplug by pulling on the cord.
16. Always unplug the unit before moving or cleaning, or whenever the heater is not in use.

IMPORTANT INSTRUCTIONS

17. Use only for intended household use as described in this manual. Any other use not recommended by the manufacturer may cause fire, electric shock, or injury to persons. The use of attachments not recommended or sold by unauthorized dealers may cause hazards.
18. Always use on a dry, level surface. Use on floor only.
19. DO NOT use outdoors.
20. WARNING: To reduce the risk of fire or electric shock, DO NOT use this unit with any solid-state speed control device.
21. DO NOT attempt to repair or adjust any electrical or mechanical functions on this unit. Doing so will void your warranty. The inside of the unit contains no user serviceable parts. Qualified personnel should perform all servicing only.

SPECIFICATIONS

Voltage Rating	120 V (60Hz)
Power Consumption	1500W
Unit Size	37.4 in. (W) x 3.7 in. (D) x 22.4 in. (H)

SAFETY FEATURE

OVERHEAT SAFETY FEATURE

This heater is equipped with an overheat safety feature. When the heater's internal components reach a certain temperature that could cause overheating or possible fire, the heater will automatically shut off.

WARNING: It is normal for the power cord to feel warm to the touch; however, a loose fit between the outlet and the plug may cause overheating of the plug. If this occurs, try inserting the plug into a different outlet. Contact a qualified electrician to inspect the original outlet for damage.

PRODUCT OPERATION METHOD

01. WALL-MOUNTED
02. TABLETOP

IN THE BOX

- ELECTRIC FIREPLACE
- REMOTE CONTROL (INCLUDE BATTERIES)
- INSTRUCTION MANUAL
- ROCK
- WALL HANGING HOLDER
- TWO STANDING LEGS
- EIGHT 4*16MM SCREWS (TO FIX STANDING LEGS)
- FIVE 4*45MM SCREWS (TO FIX WALL HANGING HOLDER)
- FIVE SCREW EXPANSION TUBES (TO FIX WALL HANGING HOLDER)

PRODUCT DIAGRAM

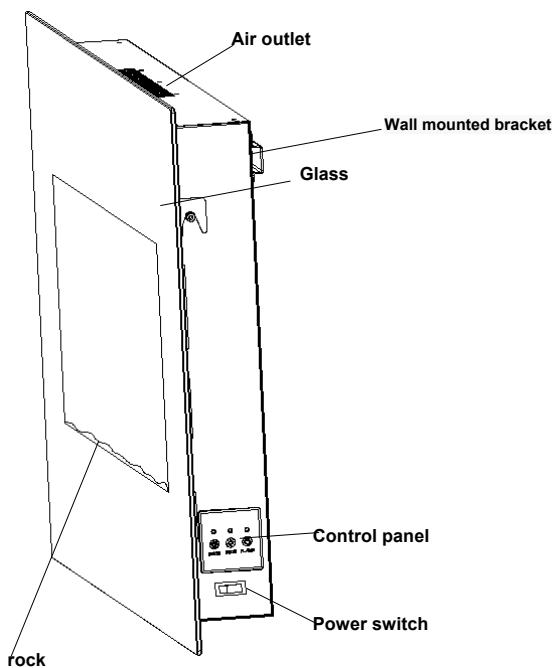

CONTROL PANEL

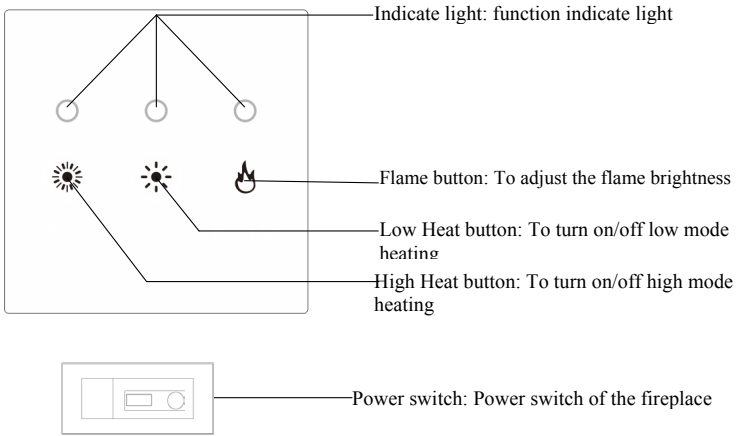

REMOTE CONTROL

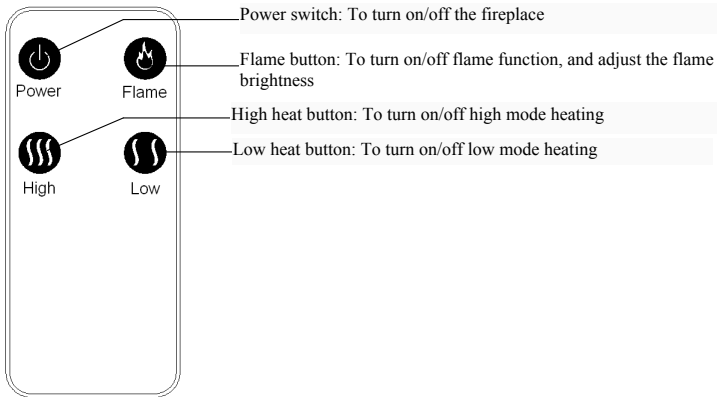

PREPARATION

The heater can be wall-mounted or placed on the ground, which can be used in the living room or bedroom. Plug the unit into a 120 V 60 Hz electrical outlet, and open the switching power supply. Bring out the insulating film when used the remote control, see as the following steps.

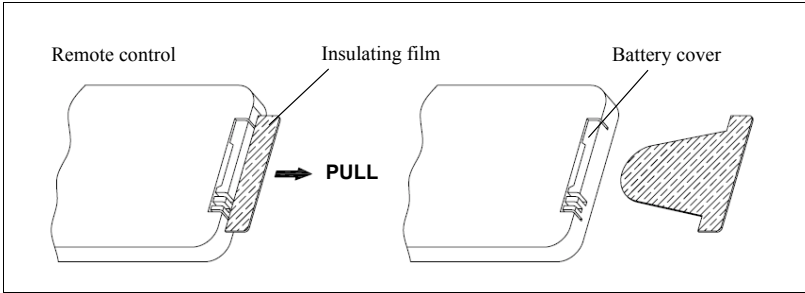

WALL-MOUNTED INSTALLATION INSTRUCTIONS

Your new electric fireplace may be installed virtually anywhere in your home. However, when choosing a location be sure to follow the general instructions included. For best results install out of direct sunlight. Power supply service must be either completed or placed within the electric fireplace prior to finishing to avoid reconstruction.

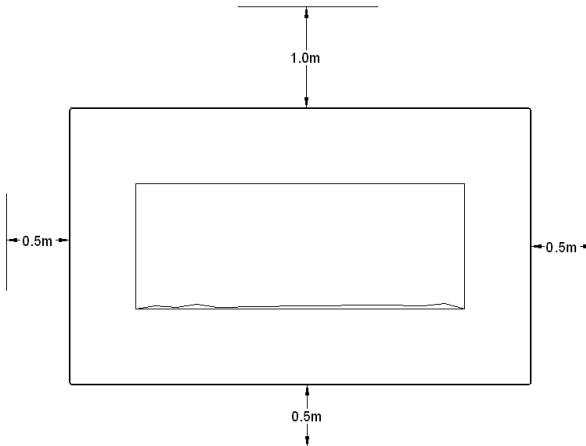

WALL-MOUNTED INSTALLATION



Warning: to prevent fire, there is no other furniture on the top of the fireplace, the following are the minimum distance from the front and side of the heater to the wall.

Up	1.0m
down	0.5m
left	0.5m
right	0.5m

Warning: check the wall to ensure that there are no wires, pipes, etc. when drilled holes in this area.

Warning: the product is not plugged in before hanging wall.

Warning: the heater cannot be fixed in the hollow wall. The heater must be installed on the solid wall.

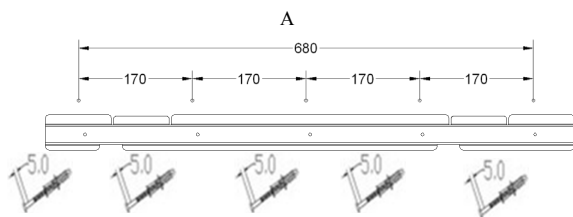

WALL-MOUNTED INSTALLATION

Exactly align to hole and hang on the fireplace.

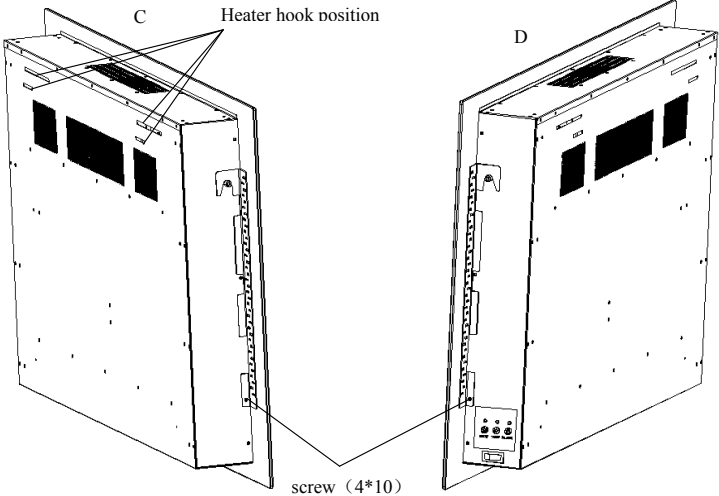
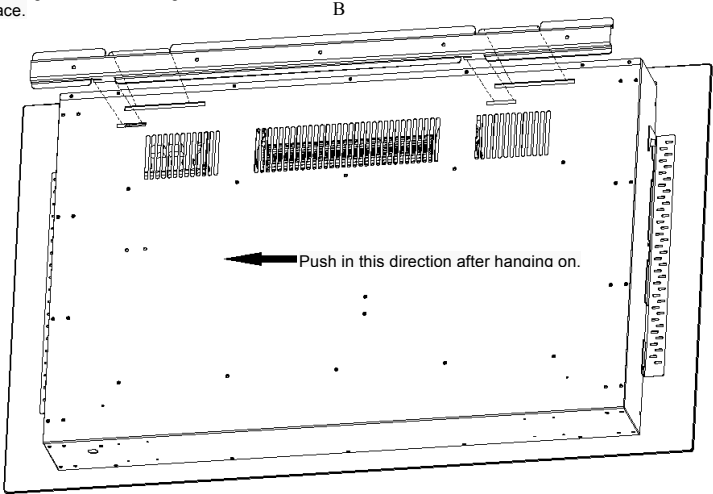

WALL-MOUNTED INSTALLATION

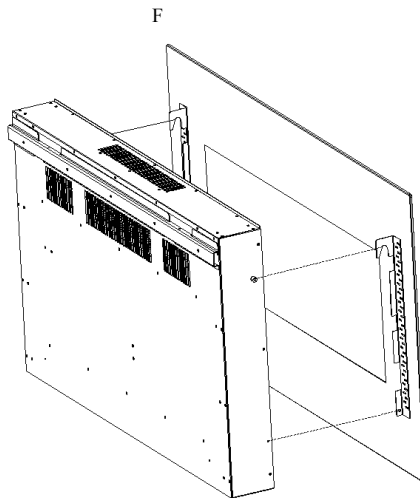
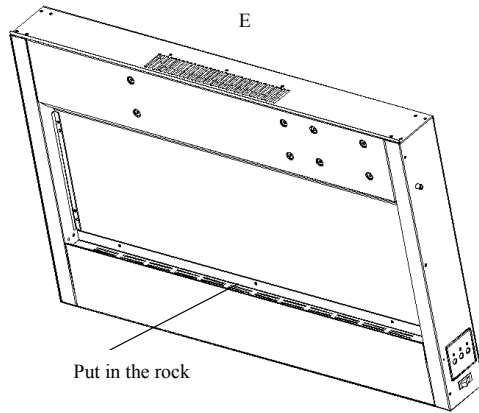

01. Fix the wall hanging holder on the wall by using the 4*45mm screws and screw expansion tubes. (As shown in figure A)
02. the heater hanging on the wall above the bracket (as shown in Figure b), then to about two screws loosen (as shown in Figure CD), the glass components to take down, pebble is placed inside the slot (as shown in Figure E), then glass component mounted back to the original place (figure f shown), lock screw, plug in the power.
03. Note: if you choose to hang on the wall, you can no longer be fixed to the support of the product.

TABLETOP INSTALLATION INSTRUCTIONS

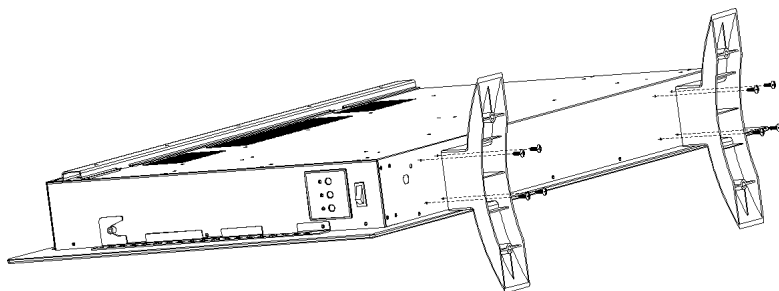

- 1, Use 4*16mm screws to support the foot fixed on the product, as shown above.
- 2, Note: if you choose to put on the ground, don't need the hanging bracket is fixed on the wall.

OPERATING INSTRUCTIONS

01. Firstly, turn on the power switch on the right side of the fireplace, which can provide the power supply to all the function of the fireplace. Only in the state of mode I, the function will be operated, including the using of remote control.



Press the power key on the remote control, at this time is to open the heating function and flame effect. Then press the power key, the heating function and flame effect will stop work (fan will close after delaying 30 seconds), and enter standby state.

02. ADJUST THE FLAME BRIGHTNESS

In standby mode, press the fire key, you can appreciate the flame effect.





FLAME or Flame

In standby mode, press the fire key, it is opened the brightest flame (the heating indicator will light up). The charcoal component will light up, and presses the flame key again, the brightness of the flame decrease. You can set up the whole five gears flame brightness, including close, by pressing the flame key circularly.

OPERATING INSTRUCTIONS



03. HEATING THE LOW MODE

In standby mode, press the heat key of the first gear and can be opened the heating function.

 750W Or Low	 In standby mode, press the heat key on the control panel or remote control, the heating function is turned on (the heat indicator will light up). Then press the heat key on the control panel or remote control again, the heat function and the heat indicator are closed, at meanwhile, the fan will close after delaying 30 seconds.
--	---

4. HEATING THE HIGH MODE

In standby mode, press the fire key, you can appreciate the flame effect.

 1500W Or High	 In standby mode, press the heat key on the control panel or remote control, the heating function is turned on (the heat indicator will light up). Then press the heat key on the control panel or remote control again, the heat function and the heat indicator are closed, at meanwhile, the fan will close after delaying 30 seconds.
--	---

MAINTENANCE

01. Turn off the heater of the power switch.
02. Unplug the unit and let it cool completely.
03. To keep the heater clean, the outer shell may be cleaned with a soft, damp cloth. You may use a mild detergent if necessary. After cleaning, dry the unit with a soft cloth. **CAUTION: DO NOT** let liquid enter the heater.
04. **DO NOT** use alcohol, gasoline, abrasive powders, furniture polish, or rough brushes to clean the heater. This may cause damage or deterioration to the surface of the heater.
05. **DO NOT** immerse the heater in water.
06. Wait until the unit is completely dry before use.
07. If won't use the unit for a long time, please take out battery in remote control according to following steps, then take care of the remote control.

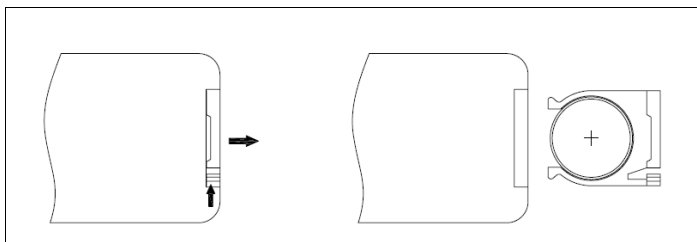

STORAGE

Store the heater in a cool, dry location when not in use. To prevent dust and dirt build-up, use the original packaging to repack the unit.

TROUBLE SHOOTING

If the heater will not operate, please check the following before seeking repair advice:

01. Check if the power cord is plugged into an electrical outlet, if not, plug in.
02. Check if electricity to the main power switch (in the back) is working.
03. Check the power switch is on

LIMITED TERM WARRANTY

ONE (1) YEAR FROM DATE OF PURCHASE

WARRANTY TERMS

DELLA warrants that its merchandise are free from manufacturing defects (workmanship and/or material) and will either give credit or replace defective parts for a period of up to one (1) year from the date of purchase in accordance with the conditions set forth below. If a manufacturing defect is found, DELLA should be notified promptly of the defect and supplied a copy of the invoice and delivery ticket. Inspection by a DELLA employee or representative may be necessary to verify that a manufacturing defect exists, or you may be required to submit samples to DELLA along with a digital image of the defects. If replacement is required in accordance with this warranty and the defective material or merchandise has been discontinued or unavailable, DELLA reserves the right to select and supply similar merchandise or offer full credit for the merchandise; otherwise the same material or merchandise will be supplied for replacement purposes. This warranty is made solely to the retailer and is not transferable under any circumstances. It is the retailer's responsibility to contact DELLA with a claim. We will not handle claims from consumers directly; all requests must go through the retailer who sold the merchandise to the consumer. We advise all retailers to retain invoices for a minimum of one (1) year for warranty purposes. This warranty supersedes and replaces all implied warranties of merchantability and use for particular purpose. No representative, employee, or agent of DELLA or any other person is authorized to assume for DELLA any additional liability or responsibility in connection with DELLAs merchandise except as described above. Implied warranties or merchantability and fitness of the merchandise are limited to a period of one (1) year from the date of purchase. In no event shall DELLA be liable for indirect, consequential or incidental damages of any kind.

ADDITIONAL CONDITIONS

The following examples are not manufacturer's defects:

- Colors may vary slightly from the photo because of photography and printing tolerances.
- Sizes are stated in U.S. standard measurements while the actual sizes are manufactured using the metric system. Therefore the sizes may vary slightly.
- There are no exchanges or refunds on any pillows or toppers sold.
- No returns for buyer's remorse.
- * No returns - other than stated above - will be accepted

ADDITIONAL CONDITIONS

Warranty is void for any of the following conditions:

- 1 Improper maintenance or improper use resulting in damage.
- 2 Any product modifications by dealer, consumer, or other parties not authorized by DELLA will void this warranty.
- 3 Floor samples sold or products designated "AS IS" at the time of purchase are not covered by the warranty.
- 4 Warranty does not cover minor variations or differences between floor samples or printed illustrations and your furniture.
- 5 Cost of packaging and shipping to and from DELLA is not covered by the warranty unless expressly arranged by DELLA.
- 6 This warranty covers only articles of appliances intended for residential use only, does not cover any industrial, commercial, institutional, or rental use.
- 7 Dissatisfaction due to buyer's remorse.
- 8 Normal wear and tear.
- 9 Damages incurred during transportation.
- 10 Damages incurred during assembling or maintenance.
- 11 Damages incurred by accidents or abuse.

Additional conditions for warranty on upholstery are listed on the attached addendum.

DELLA[®]

**WARNING: READ THIS INSTRUCTION MANUAL CAREFULLY BEFORE USE.
www.dellaproductsusa.com 909.344.2588
